

C CISTERMISER

Sensazone

Installation
guide

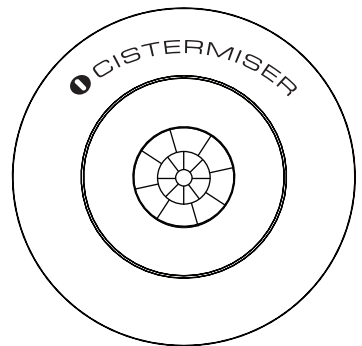

Please keep this booklet for future reference.

Installer, when you have read these instructions
please ensure you leave them with the user.



SZ/7_D-01

1. System requirements

Sensazone is an intelligent PIR sensor operated system which controls the water supply, light and fan functions in washrooms.

The system features can be used in the following scenarios:

Scenario	Required control	Required products
1	To control the water supply to one zone, room or area of a washroom (with a single/common entrance).	Sensazone core product
2	To control the water supply and lights and fans to one zone, room or area of a washroom (with a single/common entrance).	Sensazone core product A Sensazone Light and Fan Control
3	To control the water supply to multiple areas of a washroom simultaneously. Examples include, a washroom divided into different areas and a washroom with two or more entrances.	Sensazone core product Additional Sensor Kits Additional Valve Kits (where applicable, to a maximum of 3 valves per sensor)
4	To control the water supply, lights and fans to multiple areas of a washroom (with two or more entrances).	Sensazone core product A Sensazone Light and Fan Control Additional Sensor Kits Additional Valve Kits (where applicable, to a maximum of 3 valves per sensor)

Sensazone core – supplied parts

1. Solenoid valve**
2. Pipe compression fitting*
3. Pipe compression fitting with isolation valve*
4. Inlet filter*
5. Fibre washer*
6. Sensor assembly consisting of sensor unit and backplate
7. Mains power adapter
8. 2 x Universal fixing plug
9. 2 x #6 x 1½” screws
10. 4 x #4 x ½” screws
11. Sticky pads x 4
12. Extension cable to solenoid valve (3m)

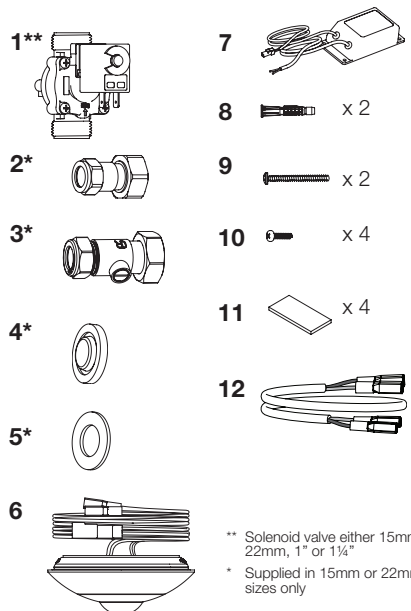

** Solenoid valve either 15mm, 22mm, 1" or 1½"

* Supplied in 15mm or 22mm sizes only

Sensazone – optional parts

1. Infrared Control Unit (ICU)
2. Split cable
3. 1.25m, 6m power extension cable
4. 1.5, 3, 6, 9m solenoid extension cables

1



2

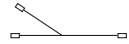

3

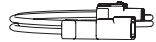

4

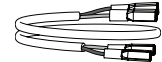

Additional Sensor Kit – supplied parts

1. Sensor assembly consisting of sensor unit and backplate
2. Universal fixing plug x 2
3. #6 x 1½” screws x 2
4. Extension Cable

1

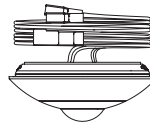

2



x 2

3



x 2

4

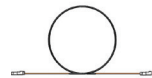

Sensazone Light and Fan Control (SZ/LFC) – supplied parts

1. Sensazone Light & Fan Control
2. Screws x 2
3. Universal fixing plug x 2
4. Sticky pads x 4

1

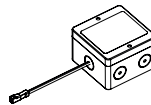

2



x 2

3



x 2

4



x 4

Additional Valve Kit – supplied parts

1. Solenoid valve**
2. Pipe compression fitting*
3. Pipe compression fitting with isolation valve*
4. Inlet filter*
5. Fibre washer*
6. Piggy back cable

1

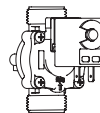

2



3



4



5



6



** Solenoid valve either 15mm, 22mm, 1" or 1¼"
* Supplied in 15mm or 22mm only

2. Guidance on system layout

Prior to installing any components, it is important to confirm the required location of the sensor(s). Once the location(s) have been confirmed, refer to Section 3 to set up the installation.

Example layout for single (common) entrance:

Scenario 1 and Scenario 2

When occupancy is detected in the common entrance, the water, lights and fans will be activated in all areas of the washroom.

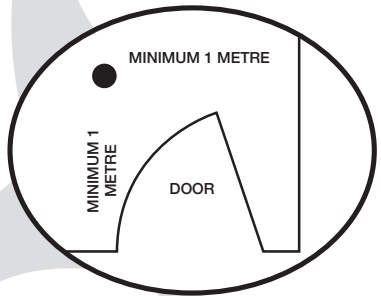
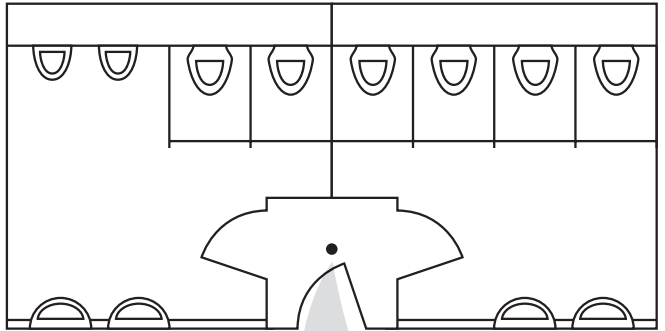

Example layout for multiple entrances:

Scenario 3 and Scenario 4

When occupancy is detected at one of the entrances, the water, lights and fans will be activated in all areas of the washroom.

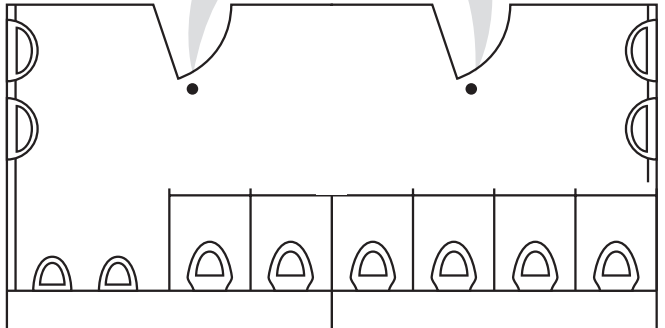

3. Installation schematic

- A** Sensor(s) installation: Refer to page 7 for details
- B** Valve installation: Refer to page 9 for details

- C** SZ/LFC installation: Refer to page 10 for details
- D** Mains power adapter: Refer to page 10 for details

Scenario 1

Max 10 metre cable length (1.5mm² CSA) between sensor (A) and furthest valve

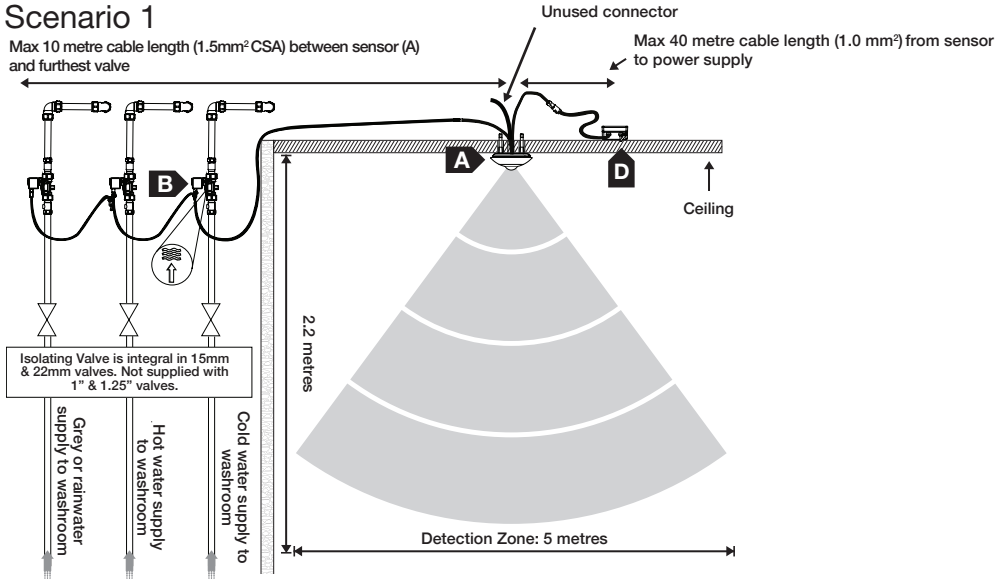

Scenario 2

Max 10 metre cable length (1.5mm² CSA) between sensor (A) and furthest valve

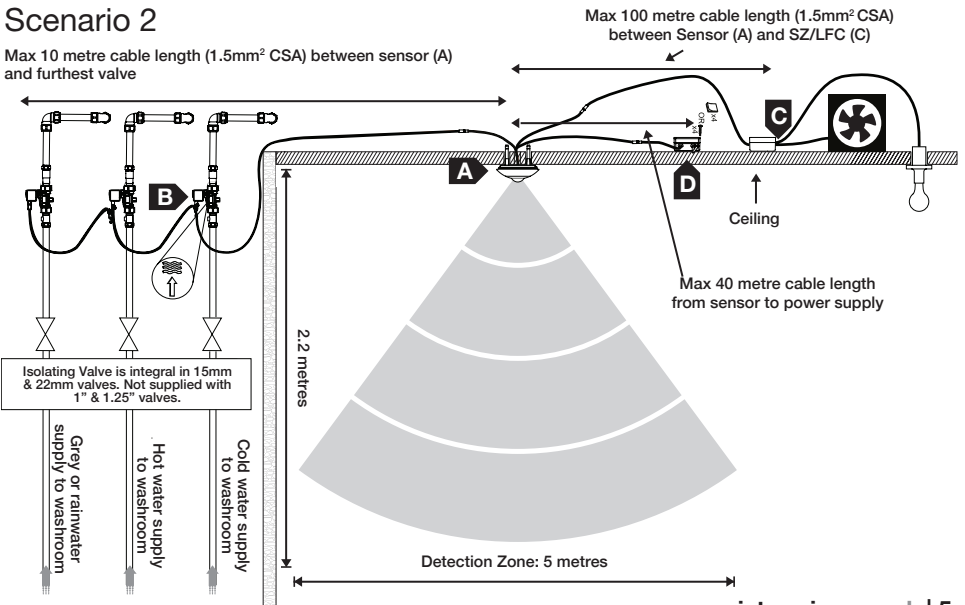

3. Installation schematic

- A** Sensor(s) installation: Refer to page 7 for details
- B** Valve installation: Refer to page 9 for details

- C** SZ/LFC installation: Refer to page 10 for details
- D** Mains power adapter: Refer to page 10 for details

Scenario 3

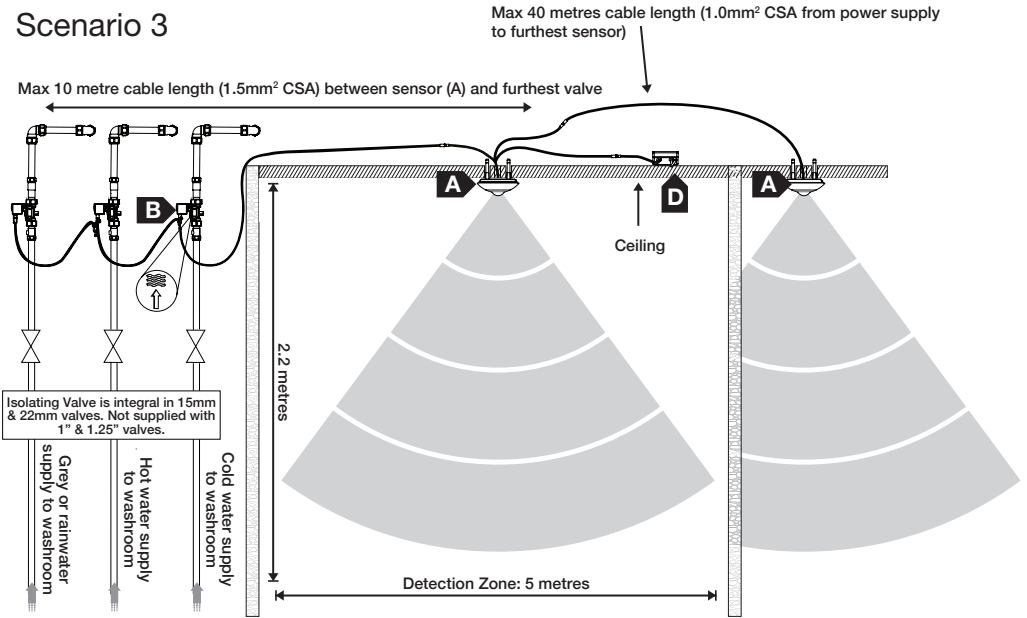

Scenario 4

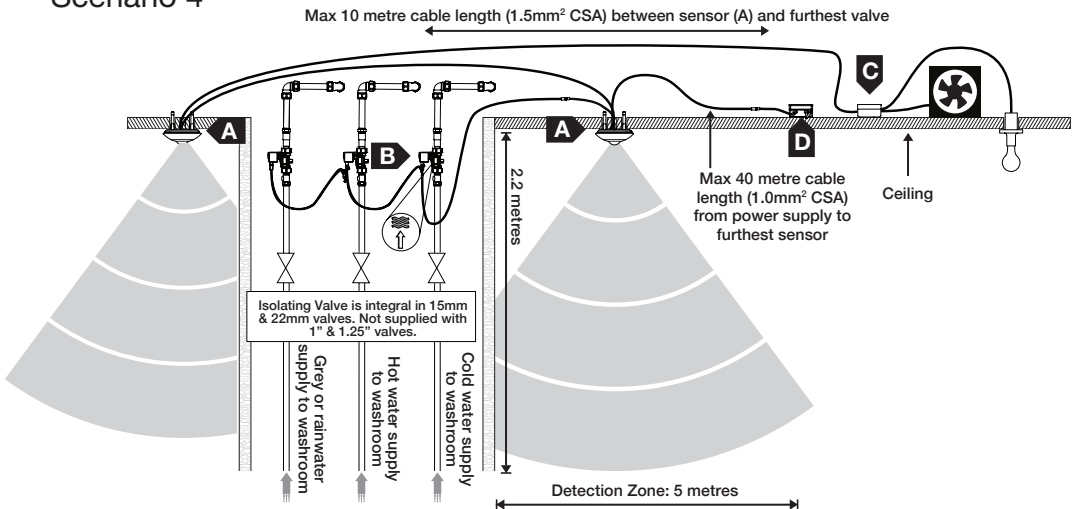

A

Sensor(s) installation

NOTE:

A max of 10 sensors can be used per system. Position the sensor(s) at least 1 metre from the entrance(s). If cables are extended 1.0mm² CSA cable must be used.

False ceiling

1. Detach the backplate from the sensor unit.
2. Offer the backplate to the ceiling and mark position of holes.
3. Drill 6mm diameter holes and insert fixing plugs.
4. Drill an additional hole of 10mm diameter between the two 6mm holes as shown here.
5. Screw the base plate to ceiling.
6. Feed the wire through the large (10mm) centre hole and secure the sensor unit to the base plate.
7. Twist sensor unit clockwise into backplate to lock into position.

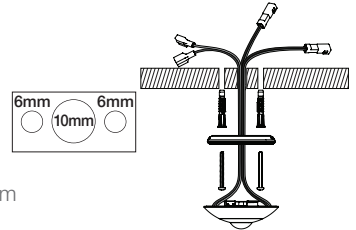

Solid ceiling

1. Detach the backplate from the sensor unit.
2. Offer the backplate to the ceiling and mark the position of holes. Pay particular attention to ensure that the 'wire exits' are correctly positioned for your installation.
3. Drill 6mm diameter holes and insert fixing plugs.
4. Screw base plate to ceiling.
5. Ensure wire is fed through the 'wire exits' as displayed on the sensor. If the wire is required to go out of the same exit ensure that the wire is routed around the sensor as shown in the diagram below.
6. Secure sensor unit to base plate and twist clockwise to lock into position.

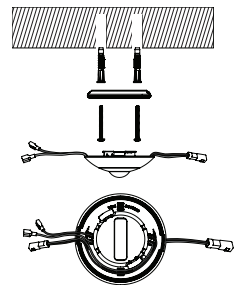

B Adding additional sensor units

The user-detection area of the Sensazone system can be increased by adding additional ceiling sensor units. A second sensor can be connected directly to the primary sensor via the male & female connector plugs.

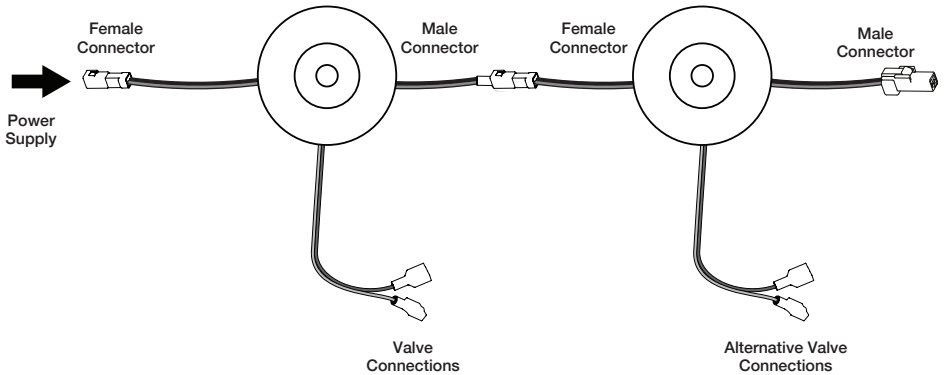

1. The cable length from sensor unit to the furthest valve must NOT exceed 10m.
2. A maximum of 10 sensors can be used per system.
3. Position the sensor(s) at least 1 metre from the entrance(s).
4. If sensor cables are extended, a 1.0mm² cable must be used.

Valve installation

Connect the valve to the spade connectors on the sensor.

NOTE:

Valves can be connected to any sensor. Maximum 3 valves per sensor.

Install valve on to the water supply leading into the washroom (hot, cold and rain/ grey water) or as close as practically possible to the entry point to suit the pipe layout.

The 15mm and 22mm valves feature integral isolation valves.

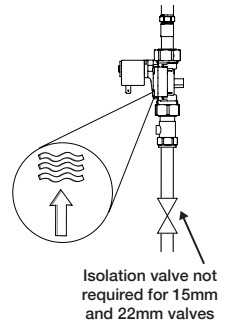

Single valve installations

Connect the spade connectors from any sensor unit to the solenoid tabs taking care to connect the wires according to the label. The solenoid cables are orange and turquoise. If these are not long enough they can be extended by up to 10 metres (1.5mm² cable).

NOTE:

Should you require extension cables for the solenoid valves please contact Cistermiser technical services.

Multiple valve installations

Up to 3 valves can be connected in parallel using the 'daisy chain' cable provided in the additional solenoid valve kit (AVK). Ensure that like colours are connected. Use the 'piggy back' connectors to loop 2 or 3 valves together as shown opposite.

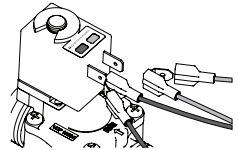

NOTE:

The furthest valves should not be more than 10m cable length (1.5mm² CSA) from the sensor.

NOTE:

For grey water/rain water harvesting. Ensure adequate filtering is fitted, a 10µm filter is recommended.

For chemical water treatment. If the water system has been treated with chemical dosing, ensure the system is thoroughly flushed before fitting any Cistermiser products. Concentrated chemicals in dead legs can damage the product and result in failure. If the water is treated with Chlorine Dioxide (ClO₂), concentration levels are maintained below 5ppm.

As with all water containing products, limescale in hard water areas can affect the products performance. This can result in maintenance to remove the limescale as and when required.

D SZ/LFC Installation

Connect the SZ/LFC to the spare connector on the sensor. The SZ/LFC can be connected to any sensor in the system. If required the cable can be extended up to a maximum length of 100m with 1.5mm² CSA cable.

1. Secure the SZ/LFC to a solid surface either with screws or the sticky pads provided.
2. Remove the top cover and pierce the appropriate rubber cable gland to connect the lights and/or fans. Take care when piercing the gland not to damage the product.

WARNING: Isolate mains supplies to lights and fans

3. Connect the live feed for the lights to the LIGHTS contactor (Ensure load does not exceed 8A)
4. Connect the live feed for the fans to the FAN contactor (Ensure load does not exceed 8A)
5. Replace lid with screws provided before restoring power.

WARNING:

This is a functional switching device, and must not be used for safety or maintenance isolation

WARNING:

This device is intended for use with hazardous voltages. The installation and maintenance of this device must be carried out by a qualified electrician in accordance with local wiring regulations. Before installing this device, please read these installation instructions carefully.

NOTE: Do not install near localised heat source

NOTE: Where necessary use wiring conduit to protect exposed cables

E Mains power adapter

Wire the mains adapter into a 1A fused spur.

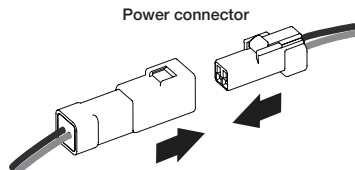
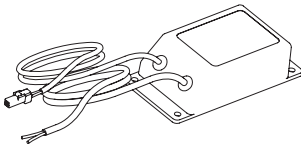

Connect the power connector from the sensor unit to the mains adapter. Colour conventions are brown for positive and grey for negative.

NOTE:

The mains power adapter should not be more than 40 meters cable length 1.0mm² from the furthest sensor.

4. Testing and commissioning

Start up operation

When the Sensazone is powered up the LED will be a constant amber for up to 15 seconds, after which it will flash amber for 5 seconds. The water supply(ies) into the washroom will now be on for the default run-on time of 15 minutes. The default run-on time can be changed to 30 minutes. See the ICU guide in section 7.

Normal operation

When movement is detected, a signal is sent to open the valve(s) and the LED will flash green once every three seconds when a single sensor is installed. If movement is detected during the run-on time the timers are re-set and will keep the valve(s) open for a further 15 or 30 minutes from the time movement was last detected.

Testing

This can be done using the Infrared Configuration Unit (ICU) which is sold separately – See ICU guide in section 7 – activating walk test.

LED indication on Sensor:

1 green flash per second	Valve opens / Lights on / Fans on
Constant red	Valves locked closed (See Section 7 – activating clean mode)
Constant amber	Valves locked closed for 10 minutes (See Section 7 – activating clean mode)
Constant green	Valves locked open (See Section 7 – activating clean mode)
1 red flash per second	Low supply voltage (Check max cable length)
2 red flashes per second	Solenoid short (Check wiring and contact Cistermiser)

LED indication on SZ/LFC:



WARNING:

Isolate mains supply to lights and fans before removing cover to reveal status LED

Constant green	System idle and OK
1 green flash per second	Fan on
2 green flash per second	Fans and lights on
1 red flash per second	Low supply voltage (Check wiring and contact Cistermiser)
2 red flashes per second	Comms failure (Check wiring and contact Cistermiser)

Power loss (valve) setting

Sensazone can be programmed to automatically open or close the valve(s) in the event of power loss.

The options are:

- Valves close in the event of power loss
- Valves open in the event of power loss
- Valve remain in their present state in the event of power loss

This can be done using the Infrared Configuration Unit (ICU), sold separately. See section 7.

Usage advice and specification

15mm & 22mm valves:	Max pressure 6 bar	Min pressure (dynamic) 0.5 bar
1" and 1.25" valves:	Max pressure 5 bar	Min pressure (dynamic) 0.5 bar
Ambient Temperature Range:	Operating 0 to +40°C	Storage -25 to +40°C

SZ/LFC

Rated voltage:	240VAC
Rated current:	8A
Making capacity:	16A for 1 second
Breaking capacity:	4000VA
Max wire size:	2.5mmsq
Ingress Protection:	IP54

NOTE:

Circuits must have overload/fault protection of 10A or less.

Circuit protection and wire size must meet local wiring regulations.

Rated Current is for a resistive load – when using inductive/capacitive loads such as fluorescent ballasts, please derate the load to ensure the inrush current does not exceed the contact making capacity.



WARNING:

This is a functional switching device, and must not be used for safety or maintenance isolation.

This device is intended for use with hazardous voltages. The installation and maintenance of this device must be carried out by a qualified electrician in accordance with local wiring regulations. Before installing this device, please read these installation instructions carefully.

Sensor

Control classification:	Independent
Maximum load:	3 x 2W 0.33A (6VDC) EMC emissions tested at load
Rated temperature range:	0-40 deg C
Action classification:	Type 1.Y
Pollution classification:	Degree 1
Ingress protection:	IP55 or IP65 (with respect to room when smooth, non-porous ceiling tile used)

Factory settings

Range:	~2.2m high x 5m diameter
Sensitivity setting:	Medium
Hygiene rinse:	On (30 min every 12 hours)
Run-on time:	15 minutes
Additional fan run-on time:	Off
Power loss:	Valves close with loss of power

5. Component dimensions

SZ_LFC

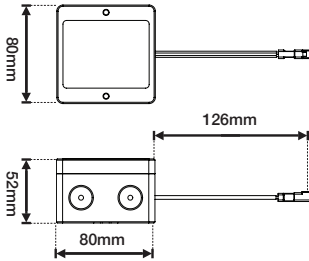

Sensor

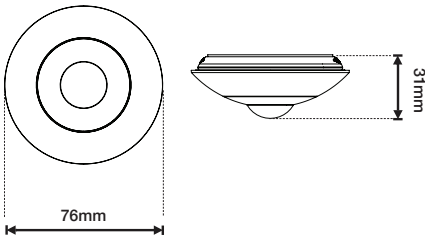

15mm or 22mm valve

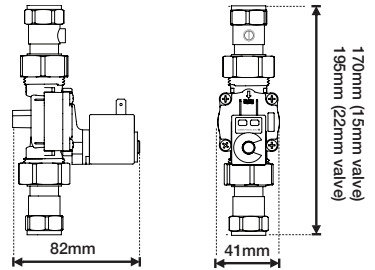

1" valve

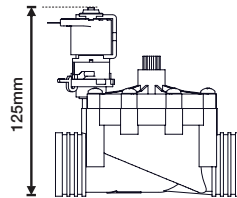
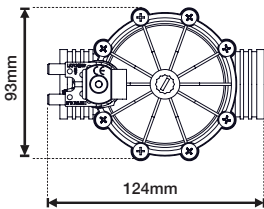

1 1/4" valve

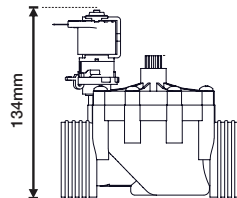
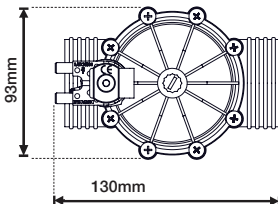

6. Advanced settings guide

NOTE: Manual configuration of the sensor is not available when connected to SZ/IF.

- 1 Disconnect power, wait for 5 seconds and reconnect.

NOTE:

Sensor LED is constant amber for up to 15 seconds while checking ambient light level. If the ambient light level is not sufficient the sensor will automatically go into normal operation. To change settings increase light level in the room or purchase ICU.

- 2 When flashing amber

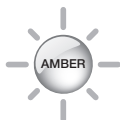

Cup hand over the sensor for 2 seconds only to enter into the run-on time configuration mode. LED will be **constant green**.



- 3 You are now in configuration mode

If a hand is not placed over the sensor, it will go into normal operation mode.

Option 1: Run-on time adjustment (15 minutes)

- A Wait for single green flashing LED.



- B Cup your hand over the sensor for 2 seconds to select this option. The LED will be **constant green** for 5 seconds.



Option 2: Run-on time adjustment (30 minutes)

- A Wait for double green flashing LED.



- B Cup your hand over the sensor for 2 seconds to select this option. The LED will be **constant green** for 5 seconds.



Sequence of programme once option has been selected

- A Once your option has been chosen, the LED will be **constant green** for 5 seconds.



- B The LED will then be **constant amber** for 5 seconds.



- C The LED will then **flash amber**, giving the opportunity to re-enter configuration mode.

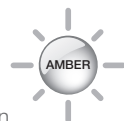















NOTE:

If a hand is held over the sensor for more than 10 seconds the sensor will go into normal operation mode.

7. Infrared Configuration Unit (ICU) guide

NOTE: Sold separately

Button descriptions

-  Activates cleaning mode
 -  Activates ICU configuration mode
 -  Decreases setting
 -  Increases setting
 -  Checks the setting being altered
 -  Saves changes and exits ICU configuration mode
 -  Quits ICU configuration mode without saving changes
1.  Configures sensor range
 2.  Configures light threshold
 3.  Configures fan run-on time
 4.  Configures occupancy (run-on) time
 5.  12 hour hygiene cycle activation
 8.  Power loss valve setting
 9.  Resets to default factory settings

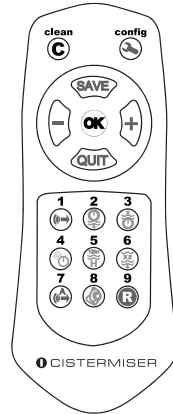

Activating walk test

When the Sensazone is in normal operation, point the ICU at the Sensazone and press 1 . The Sensazone will flash green every time it detects movement. This confirms that the unit is operating as it should be. After two minutes of no movement, the sensor returns to normal operation. The product must be put into ICU configuration mode before any setting can be configured.

Activating clean mode

Point the ICU at the Sensazone (in normal operation mode) and press the clean button . This will lock the solenoid valve(s) open or closed.

- 1 - lock open indefinitely (steady green LED)
- 2 - lock closed indefinitely (steady red LED)
- 3 - lock closed for 10 minutes (steady amber LED)
- 4 - normal operation (LED out)

Repeatedly pressing the clean mode will cycle through the 4 states. If a delay of 4 seconds occurs after pressing the clean button, the valve(s) remain in that state. To return to normal operation press the clean button 4 times.

Entering configuration mode

Point the ICU towards the Sensazone sensor and push the configuration  button. Activation is most effective when the configuration button is held down as the ICU is brought close to the sensor.

It can take up to 3 seconds for the product to sense the ICU. The Sensazone will return to normal operation if there are no button presses for 30 seconds.

Configuring sensor sensitivity (range)

Enter into configuration mode. Point the ICU at the Sensazone and press the 1Ⓢ; the sensor blinks green once.

Decrease or increase the sensor range by pressing the Ⓜ and Ⓟ buttons respectively. The sensor blinks green every time Ⓜ or Ⓟ is pressed and blinks red when the minimum or maximum value is reached.

Press Ⓢ button to verify the sensor sensitivity setting; the sensor displays the current setting by flashing green.

Single flash: minimum sensitivity setting.

Double flash: medium sensitivity setting.

Triple flash: maximum sensitivity setting.

Save setting and exit ICU configuration mode by pressing the Ⓢ button. The sensor will blink green for 1 second and then constant amber for 3 seconds.

To exit without saving press the Ⓢ button. The sensor will blink red for 1 second and then constant amber for 3 seconds.

NOTE:

Changing sensor sensitivity will only take effect on the individual sensor, other sensors in the system will keep their range.

Configuring light threshold (when SZ/LFC is connected)

Enter into configuration mode. Point the ICU at the Sensazone and press the 2Ⓢ; the sensor blinks green once.

Decrease or increase the light threshold by pressing the Ⓜ and Ⓟ buttons respectively. The sensor blinks green every time Ⓜ or Ⓟ is pressed and blinks red when the minimum or maximum value is reached.

Press Ⓢ button to verify the sensor light threshold setting; the sensor displays the current setting by flashing green.

Single flash: minimum sensitivity setting.

Double flash: medium sensitivity setting.

Triple flash: maximum sensitivity setting.

Save setting and exit ICU configuration mode by pressing the Ⓢ button. The sensor will blink green for 1 second and then constant amber for 3 seconds.

To exit without saving press the Ⓢ button. The sensor will blink red for 1 second and then constant amber for 3 seconds.

NOTE:

Changing light threshold will only take effect on the individual sensor, other sensors in the system will keep their light threshold settings.

Configuring fan run-on time (when SZ/LFC is connected)

Enter into configuration mode. Point the ICU at the Sensazone and press the 3Ⓢ; the sensor blinks green once.

Decrease or increase the fan run-on time by pressing the Ⓜ and Ⓟ buttons respectively. The sensor blinks green every time Ⓜ or Ⓟ is pressed and blinks red when the minimum or maximum value is reached.

Press Ⓢ button to verify the sensor light threshold setting; the sensor displays the current setting by flashing green.

Number of flashes	1	2	3	4	5
Fan run-on time (minutes)	0	5	15	30	60

Save setting and exit ICU configuration mode by pressing the Ⓢ button. The sensor will blink green for 1 second and then constant amber for 3 seconds.

To exit without saving press the Ⓢ button. The sensor will blink red for 1 second and then constant amber for 3 seconds.

NOTE:

The fan run-on time is in addition to the occupancy run-on time. Changing the fan run-on time will be common across all sensors in the network.

Activating the 12 hour hygiene cycle

Enter into configuration mode. Point the ICU at the Sensazone and press the **5** (Ⓢ): The sensor blinks green once.

Pressing the **⏪** and **⏩** buttons switches the hygiene cycle function on or off respectively. Press the **Ⓢ** button to verify the setting; the sensor displays the current setting by flashing green.

Single flash: hygiene cycle OFF

Double flash: hygiene cycle ON

Save setting and exit ICU configuration mode by pressing the **⏪** button. The sensor will blink green for 1 second and then constant amber for 3 seconds.

To exit without saving press the **⏪** button. The sensor will blink red for 1 second and then constant amber for 3 seconds.

NOTE:

Hygiene flush run-on time is 30min. When multiple sensors are connected, the hygiene cycle will be common across all sensors in the network.

Power loss (valve) setting:

Enter into configuration mode. Point the ICU at the Sensazone and press the **8** (Ⓢ): the sensor blinks green once.

Select the power loss by pressing the **⏪** and **⏩** buttons respectively. The sensor blinks green every time **⏪** or **⏩** is pressed and blinks red when the minimum or maximum value is reached.

Press **Ⓢ** button to verify the power loss setting: the sensor displays the current setting by flashing green.

Single flash: Valves close in the event of power loss

Double flash: Valves open in the event of power loss

Triple flash: Valve remain in their present state in the event of power loss

NB: the power loss feature does not impact the lights and fans operation.

Save setting and exit ICU configuration mode by pressing the **⏪** button. The sensor will blink green for 1 second and then constant amber for 3 seconds.

To exit without saving press the **⏪** button. The sensor will blink red for 1 second and then constant amber for 3 seconds.

NOTE:

When multiple sensors are connected, changes to occupancy time will be common across all sensors in the network.

Reset to factory settings

Enter into configuration mode. Point the ICU at the Sensazone and press the **9** (Ⓢ): the sensor blinks green once. This returns all settings to the default factory settings.

To save the setting and exit ICU configuration mode press the **⏪** button. The sensor will blink green for 1 second and then constant amber for 3 seconds.

To exit without saving press the **⏪** button. The sensor will blink red for 1 second and then constant amber for 3 seconds.

To activate the walk test and cleaning mode the Sensazone should be in normal operating mode.

8. Frequently asked questions

No water at outlets

Sensor LED not lit	Check electrical power supply to the sensor unit and all electrical connections to the valve.
Constant orange LED on sensor	The unit has been left in the locked closed position and will remain in this position for 10 minutes, after which it will go into normal operation. The clean button on the ICU can be pressed to return to normal operation mode.
Constant red LED on sensor	The unit has been left in the locked closed position indefinitely. However, the clean button on the ICU can be pressed to return to normal operation mode.
Sensor LED flashing green	Ensure there is a water supply to valve. Ensure you have the minimum water pressure of 0.5 bar. Check the filter at the inlet side of the valve is clear of any debris. Check all electrical connections between the sensor and valves. Check to ensure the maximum cable runs between the sensor and valve(s) have not been exceeded. There is water in one zone but not all zones. Ensure water pressure does not exceed the maximum working pressure of the valve.

Water at outlets at all times

Sensor LED not lit	Check electrical power supply to the sensor and all electrical connections to the valve. If electrical power confirmed please contact Cistermiser for further advice.
Valves not opening or closing when they should	Check all electrical connections and ensure maximum cable runs have not been exceeded. If confirmed contact Cistermiser for further advice.
Constant green LED on sensor	The unit has been left locked in the open position indefinitely. However, the clean button on the ICU can be pressed to return to normal operation mode.

8. Frequently asked questions

Other issues

Single or double red flash on sensor	Check wiring, connections and maximum cable length; if this is correct and the problem persists please contact Cistermiser.
The sensor is not sensing occupancy in the washroom	Conduct a walk test and if required adjust the sensor sensitivity setting as per section 7.

Cistermiser product warranty and extended warranty

Cistermiser products are guaranteed for 12 months from the date of manufacture. The guarantee is for faulty products and parts only: there is no labour warranty. If you believe your product is faulty, please either contact Cistermiser directly on **0118 969 1611** or at **support@cistermiser.co.uk**, with a photograph and the serial number, to help diagnose the cause of the problem.

The warranty on Cistermiser products can be extended within one year of date of manufacture, at no cost, to three years from the date of installation (see details on page 21). Please make a note of the serial number and take a photograph of the installation before you leave site.

Commissioning check-list

Sensazone

3 YEAR
extended
warranty

The warranty on Cistermiser products can be extended within one year of date of manufacture, at no cost, to three years from the date of installation. Once the valve has been installed, complete the product commissioning checklist below to demonstrate compliance with the installation instructions. Email a photograph of this completed form to warranty@cistermiser.co.uk or post to **Cistermiser, Unit 1, Woodley Park Estate, 59-69 Reading Road, Woodley, Berks, RG5 3AN.**

Product serial number

Installation address

No	Activity	Checked	Date
1.	Flush pipework prior to installation.	<input type="checkbox"/>	<input type="checkbox"/>
2.	Ensure sensor position will cause activation. Sensor should be installed 1 metre from room entrance.	<input type="checkbox"/>	<input type="checkbox"/>
3.	Ensure water supply working/dynamic pressure is between 0.5 - 6 bar (0.5 - 5 bar on larger valves)	<input type="checkbox"/>	<input type="checkbox"/>
4.	Install an isolation valve upstream of solenoid valve.	<input type="checkbox"/>	<input type="checkbox"/>
5.	Check all connections for leaks.	<input type="checkbox"/>	<input type="checkbox"/>
6.	Check flow direction of solenoid valves.	<input type="checkbox"/>	<input type="checkbox"/>
7.	Check electrical connections: sensor to solenoid, orange to orange, blue to blue. Ensure mains power is connected, wire power adapter to 1A fused spur.	<input type="checkbox"/>	<input type="checkbox"/>
8.	Test operation. Check run-on time and adjust if required (see advanced settings guide). In normal operation sensor will detect movement and flash green once every three seconds for the duration of the run-on time.	<input type="checkbox"/>	<input type="checkbox"/>

Cistermiser range

Urinal flushing

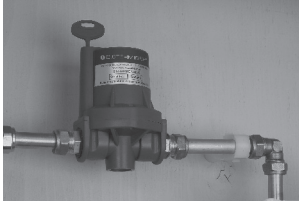

Hydraulic Valve

An automatic urinal flush control valve which reduces water consumption. The valve uses a simple patented mechanism which prevents water waste by ensuring that the auto-flush cistern is only filled, and can only flush, when the washroom is used.



Infrared Control (IRC) Valve

This valve automatically manages the water supply to the urinal cistern and reduces water consumption by up to 80%. The PIR sensor detects movement and activates the solenoid valve, allowing water into a urinal cistern.



Direct Flush Valve

An infrared sensor controlled urinal valve. It automatically flushes individual urinals after use, ensuring the highest level of hygiene from the minimum volume of water.

WC flushing



Easyflush Wave

An infrared, hands-free and water-conserving WC cistern flush valve suitable for concealed or exposed cisterns. Easy to install in retrofits or new installations, its no-touch dual flush WC cistern valve promotes water economy and hygiene in domestic and commercial washrooms.



Easyflush Walkaway

An infrared controlled automatic WC cistern flush valve that is suitable for concealed cisterns. The valve flushes once the user exits the cubicle. Ideal for use in environments where hygiene and water economy are concerns.



Easyflush Direct

An infrared electronic flushing system that removes the need for a WC cistern by taking its water feed straight from the mains supply. Ideal for high traffic areas as the system allows for a second flush without a delay.

Infrared Taps



Novatap

A contemporary deck-mounted chrome tap. The infrared control reduces water and energy usage and eliminates the risk that the tap may be left running. Internal and external valve installation options.



Vectatap

An elegantly designed infrared tap with the benefit of hygienic hands-free operation. Vectatap improves water and energy efficiency and includes auto-shut off and hygiene flush features.

Washroom control systems

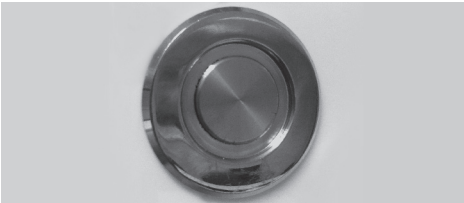

Anti-Vandal Range

Our specialist vandal-resistant range of touch-activated washroom controls; for use in high risk or demanding public environments.



Sensazone

An innovative system to conserve water and energy. Occupancy is monitored by sensors; when someone enters the washroom all services controlled by Sensazone are activated – the hot and cold water, lighting and extractor fans.

Davidson Holdings' brands

Salamander Pumps

Salamander is one of the UK's leading manufacturers of pumps for boosting water pressure for showers, bathrooms and whole house supply in domestic and small commercial tank-fed systems.

www.salamanderpumps.co.uk



Keraflo manufacture delayed action float valves, which provide an accurate and effective method of controlling the level of stored cold water in tanks both with and without raised float valve chambers. The range is used in domestic, commercial and industrial applications worldwide.

www.keraflo.co.uk



Homeboost is an intelligent pump from Salamander Pumps that recognises when water flow is less than 12 ltrs/min and automatically boosts the performance of the incoming mains water up to 12 ltrs/min.

www.home-boost.co.uk

Cistermiser Limited

Unit 1, Woodley Park Estate, 59-69 Reading Road,
Woodley, Reading, Berkshire RG5 3AN
t: +44 (0) 118 969 1611 f: +44 (0) 118 944 1426
e: sales@cistermiser.co.uk www.cistermiser.co.uk



Talon is the UK market leader in the manufacture and supply of plastic pipe clips, pipe collars and fixing plugs, plus a range of cover profiles for concealing pipework.

www.talon.co.uk



Combimate is a domestic limescale prevention device that prevents limescale build-up and soft water corrosion in combination boilers and other domestic hot water appliances.

www.combimate.co.uk



Fuelstop TFV is an overheat protection device that shuts off supply to fuel burning appliances. The FuelStop TFV complies with British safety standards and, unlike other fire valves, it is filled with liquid not gas, reducing nuisance trips.

www.fuelstop.co.uk

PENDOCK

Pendock manufacture solutions to the challenges of enclosing structures and perimeter casings for building interiors. The range includes pipe boxing, column and HVAC casings, radiator covers and washroom cubicles.

www.pendock.co.uk